

## PIIM PV 400 DS Vseries

- Surge arresters type T2 intended for photovoltaic systems (PV).
- Products are designed in a Y-type connection, which is resistant to earth faults of working conductors.
- Particular varistor sectors, connected between the terminals L+, L- and PE are equipped with internal disconnectors, which are activated when the varistors fail (overheat) and they are able to interrupt the DC current.
- Special construction of the internal disconnector allows installation without a back-up fuse.
- They are installed in PV applications without an external LPS or with an external LPS, where the sufficient distance "s" is observed.
- Suitable for all LPL levels.
- Ensure the equipotential bonding of positive and negative busbars of PV systems and the elimination of transient overvoltage that originates during the atmospheric discharges or switching processes.
- **M** indication specifies a type of construction with removable module.
- **DS** indication specifies a version with remote monitoring.

Type		PIIM PV 400 DS Vseries
Test class according to EN 61643-11:2012 and EN 61643-31:2019		T2
System		DC
PV system type		Ungrounded
SPD connection type		Y
Maximum continuous operating voltage (+/-)	$U_{CPV}$	420 V DC
Maximum continuous operating voltage ( $\pm$ /PE)	$U_{CPV}$	420 V DC
Max. voltage of PV generator $U_{OCSTC} \leq U_{CPV} / 1.2$	$U_{OCSTC}$	350 V
Short-circuit current rating	$I_{SCPV}$	10 kA
Maximum discharge current (8/20)	$I_{max}$	40 kA
Nominal discharge current for class II test (8/20)	$I_n$	15 kA
Voltage protection level at $I_n$	$U_p$	< 1.6 kV
Response time	$t_A$	< 25 ns
Housing material		Polyamid PA6, UL94 V-0
Degree of protection		IP20
Operating temperature	$\vartheta$	-40 ÷ 70 °C
Humidity range	RH	5 ÷ 95 %
Minimum cross-section of connected Cu conductors according to IEC 61643-32:2017 (doesn't apply to „V“ connection) for T2	S	2.5 mm <sup>2</sup> (L+, L-) 6 mm <sup>2</sup> (PE)
Clamp fastening range (solid conductor)		2.5 ÷ 35 mm <sup>2</sup>
Clamp fastening range (stranded conductor)		2.5 ÷ 25 mm <sup>2</sup>
Tightening moment		4 Nm
Installation		On DIN rail 35 mm
Modular width		3 TE
Operating position		Any
Product placement environment		Internal
SPD failure mode		OCFM

Type		PIIIM PV 400 DS Vseries
Signalling at the device		Optic
Importance of local signaling		OK – green target FAULT – red target
Remote signalling		Yes
Potential free signal contact (S) (recommended cross-section of remote monitoring max. 1 mm <sup>2</sup> )		AC: 250 V / 1.5 A, DC: 250 V / 0.1 A
Modular design		Yes
Article number of spare module		27 057
Lifetime		> 100 000 h
<b>Designed according to standards</b>		
Requirements and test methods for SPDs for photovoltaic installations		IEC 61643-31:2018
Safety of Flammability of Plastic Materials		UL 94
<b>Application standards</b>		
Protection against lightning		IEC 62305:2010
Selection and application principles for SPDs connected to photovoltaic installations		CLC/TS 50539-12:2010
Low-voltage electrical installations – Photovoltaic (PV) systems		HD 60364-7-712:2016
<b>Ordering, packaging and additional data</b>		
Mass	m	270 g
Mass (including the packaging)	m	289 g
Packaging dimensions (H x W x D)		60 x 111 x 87 mm
Packaging value	V	0.58 dm <sup>3</sup>
ETIM group		EG000021
ETIM class		EC000941
Customs tariff no.		85363010
EAN code		8590681122976
<b>Art. number</b>		<b>27 067</b>



The link in the QR code leads to the online presentation of the **PIIIM PV 400 DS Vseries**. There, in addition to the always up-to-date data sheet, you will also find all diagrams and drawings, declarations of conformity, or 2D or 3D models and other necessary materials. For more information, visit [www.hakil.com](http://www.hakil.com)



**Application wiring diagram (installation)**

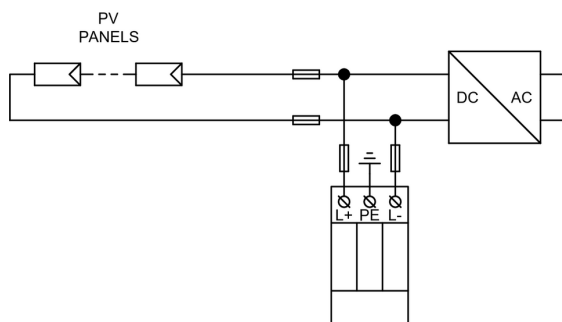

**Internal diagram**

